

Guttavordach BS 3D-Line

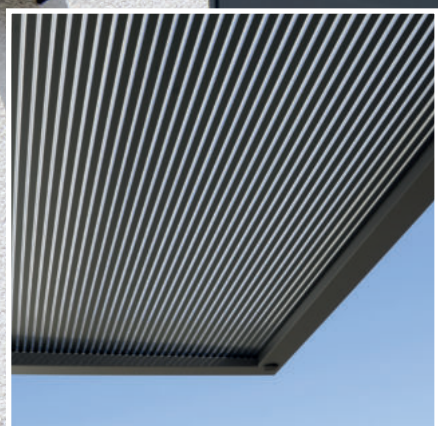

Guttavordach BS 3D-Line
č. produktu 7600303 - 7600306



Důležité upozornění











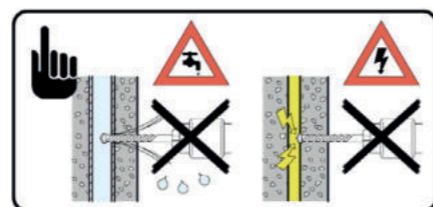



- Před montáží si prosím pozorně přečtěte montážní návod a zkontrolujte výrobek, zda nedošlo k poškození při přepravě nebo chybám, protože za poškození již smontovaných výrobků nelze převzít žádnou odpovědnost.
- Před instalací zkontrolujte, zda odpovídá typ, rozměry a barva.
- Položky vyrobené na zakázku nelze vyměnit.
- Stříška smí být používána pouze k předepsanému účelu, jinak zaniká nárok na ručení za výrobek!
- Čistěte stříšku v intervalech cca 3 měsíců. Používejte pouze přípravky doporučené prodejci (žádné abrazivní prostředky nebo rozpouštědla). Lakované díly lze v případě potřeby ošetřit i autoleštidlem.
- Odtoky vody je nutné pravidelně čistit (jinak hrozí poškození vzlináním).
- Upevňovací prvky musí být přizpůsobeny příslušnému stavu stěny. Musí být zajištěno dostatečné upevnění.
- Při zvýšené zátěži sněhem a ledem je nutné stříšku odklidit.
- Pozor, nebezpečí nehody! Baldachýn není přístupný. Doporučení: Montáž by měly provádět dvě osoby. Kromě toho musíte utěsnit komerčně dostupným silikonem.
- Elektrická instalace musí být provedena nebo schválena elektrikářem.
- Po uplynutí zákonné záruční doby nevzniká žádný nárok na opotřebitelné díly.
- K této stříšce dodáváme i samostatné příslušenství. Pro informace kontaktujte svého specializovaného prodejce.
- Vyhrazujeme si právo na změny designu.

Important Recommendations!

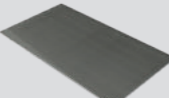

- Prior to assembly please study the assembly instructions in detail and check the consignment for possible faulty parts or damage during transportation. No liability will be assumed for damage to products already assembled.
- Please check that type, dimensions and colour match before fitting.
- Custom-made products are not exchangeable.
- The canopy may only be used for the intended purpose, failing which no claims for product liability can be accepted!
- Clean the canopy every 3 months and only use a recommended cleaning product (no scrubbing agents or solvents). If necessary, the lacquered parts can also be treated with car polish.
- The water drains should be cleaned regularly (to avoid damage caused by accumulated water).
- In each case, the canopy fastenings must be suitable for the construction of the wall in question. Secure attachment must be ensured.
- Accumulated snow and ice should be removed from the canopy.
- Caution - Risk of accident! The canopy is not load bearing; do not climb on it, or place your weight on the canopy.
- Recommendation: Assembly should be carried out by two persons. You must also seal the canopy with commercially available silicone.
- The electrical installation must be carried out or removed by a qualified electrician.
- No guarantee claims can be accepted for parts subject to wear and tear after the statutory guarantee period has expired.
- We can also supply separate accessories for this canopy. Please contact your local dealer for more information.
- The design is subject change.

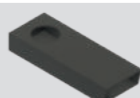
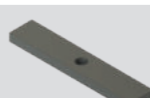

Č. No.	Popis Designation	Množství Quantity	
		BS 3D-Line 160	BS 3D-Line 200
1.	Metrický šroub Screw 10x80 mm 	6x	7x
2.	Hmoždinka Plugs průměr 12 mm 	6x	7x
3.	Podložka Washers 	6x	7x
4.	Vrut Screw 4,8x25 mm 	14x	14x
5.	Gumová podložka Dummy plug 	1x	1x
7.	Polykarbonátová deska Twin-Wall Sheet 	1x	1x
8.	Vnější rám Outer frame 	1x	1x
9.	Lišta krátká Inner angle short 	2x	2x
10.	Lišta dlouhá Inner angle long 	2x	2x
11.	Chrlič Waterspout 	1x	1x
12.	Hliníková destička Aluminum sheet 	1x	1x
13.	Metrický šroub Screw M5 x 50 mm 	1x	1x
14.	Matice M5 Nut M5 	1x	1x

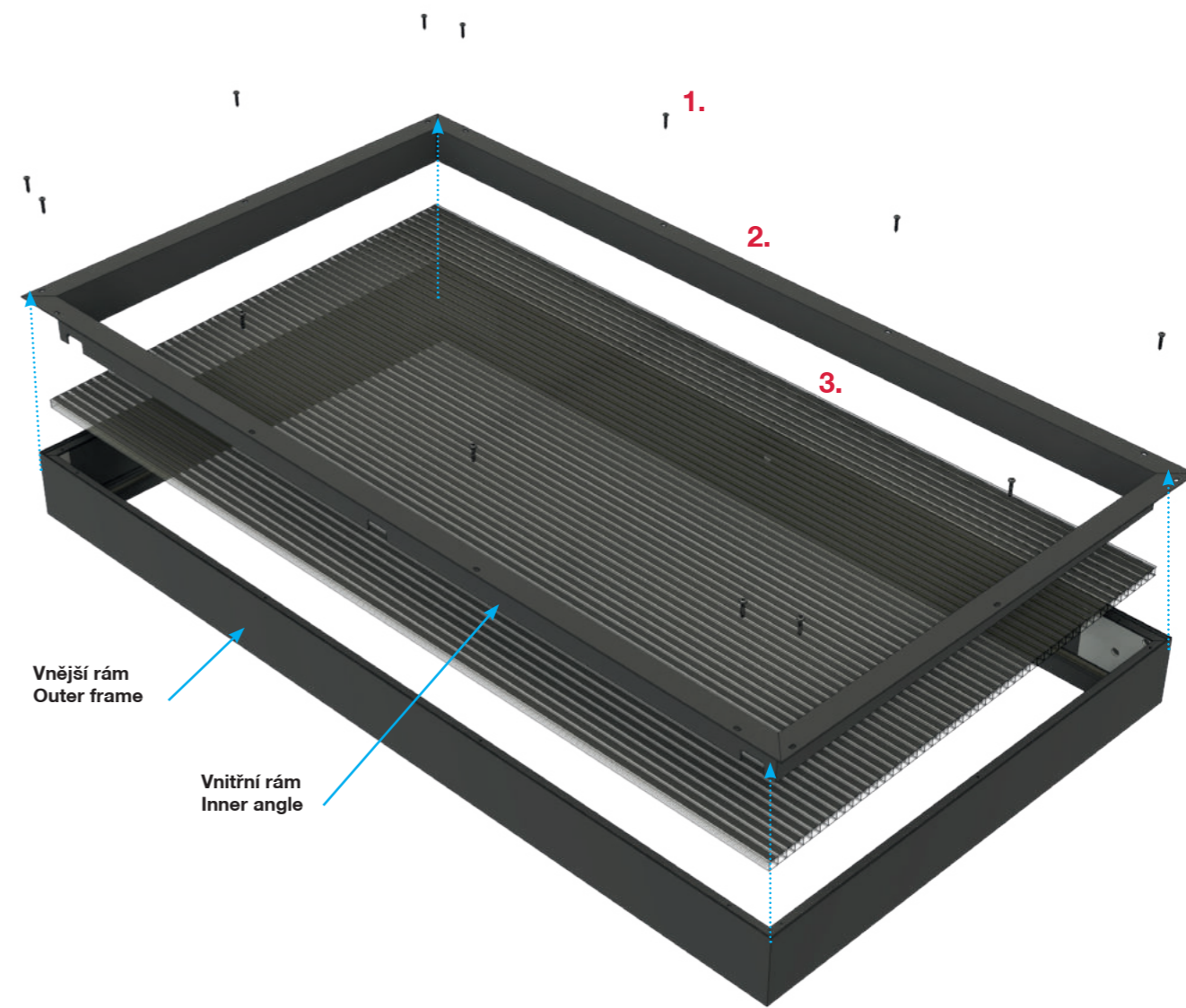
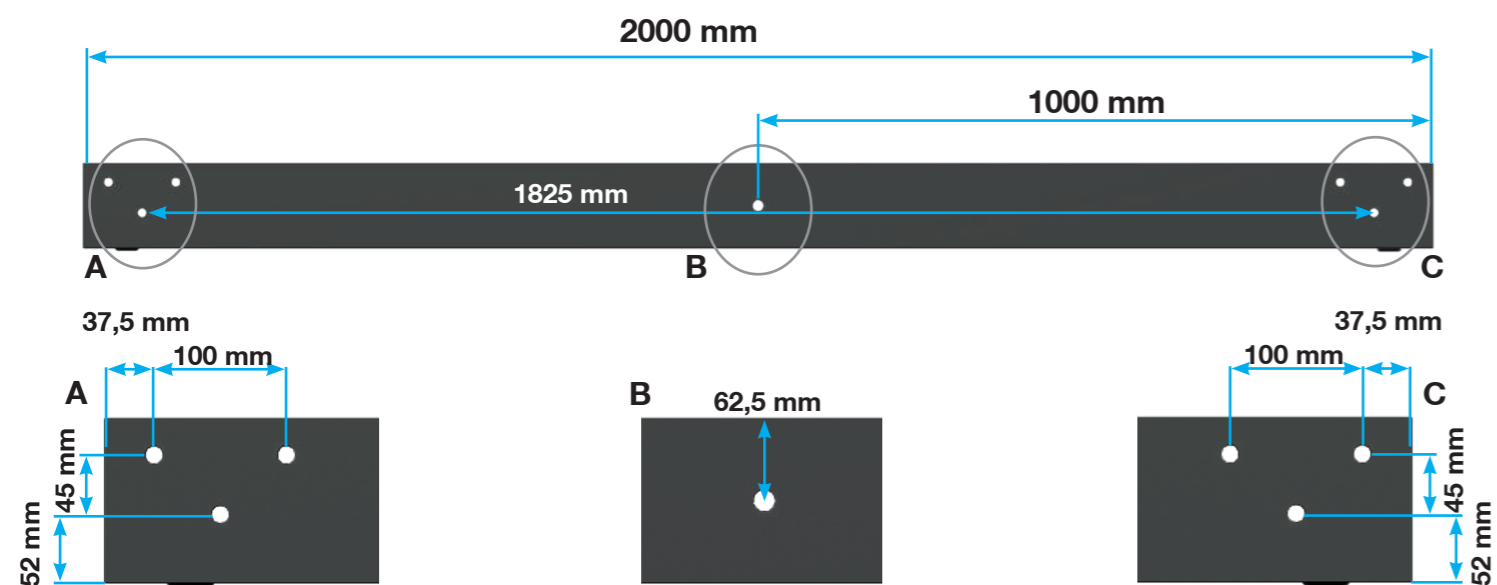
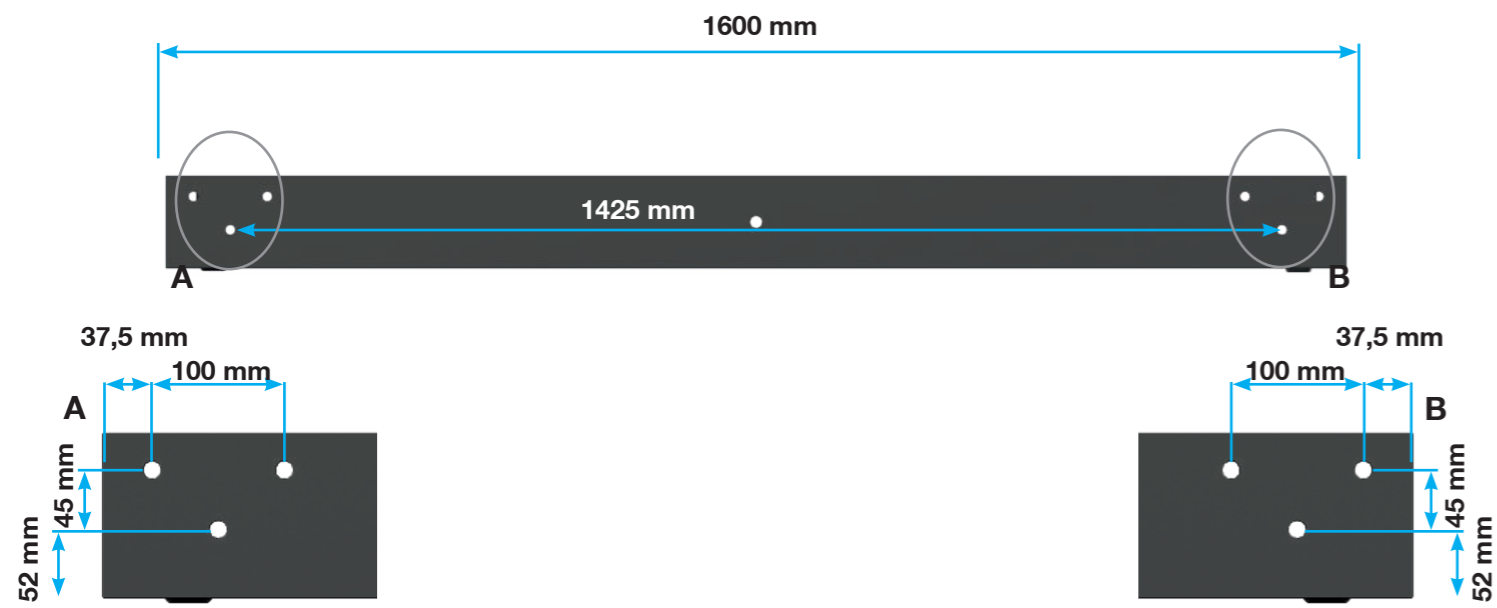

Zvedněte kryt z vnějšího rámu takto:

1. Povolte šrouby | 2. Odstraňte vnitřní úhelník |
3. Odstraňte polykarbonátovou desku - viz obrázek.

Lift the cover out of the outer frame, proceeding as follows:

1. loosen screws | 2. remove inner angle | 3. take out polycarbonate plate - see picture.

Montáž rámu BS 3D-Line 160 + 200
Montage frame BS 3D-Line 160 + 200

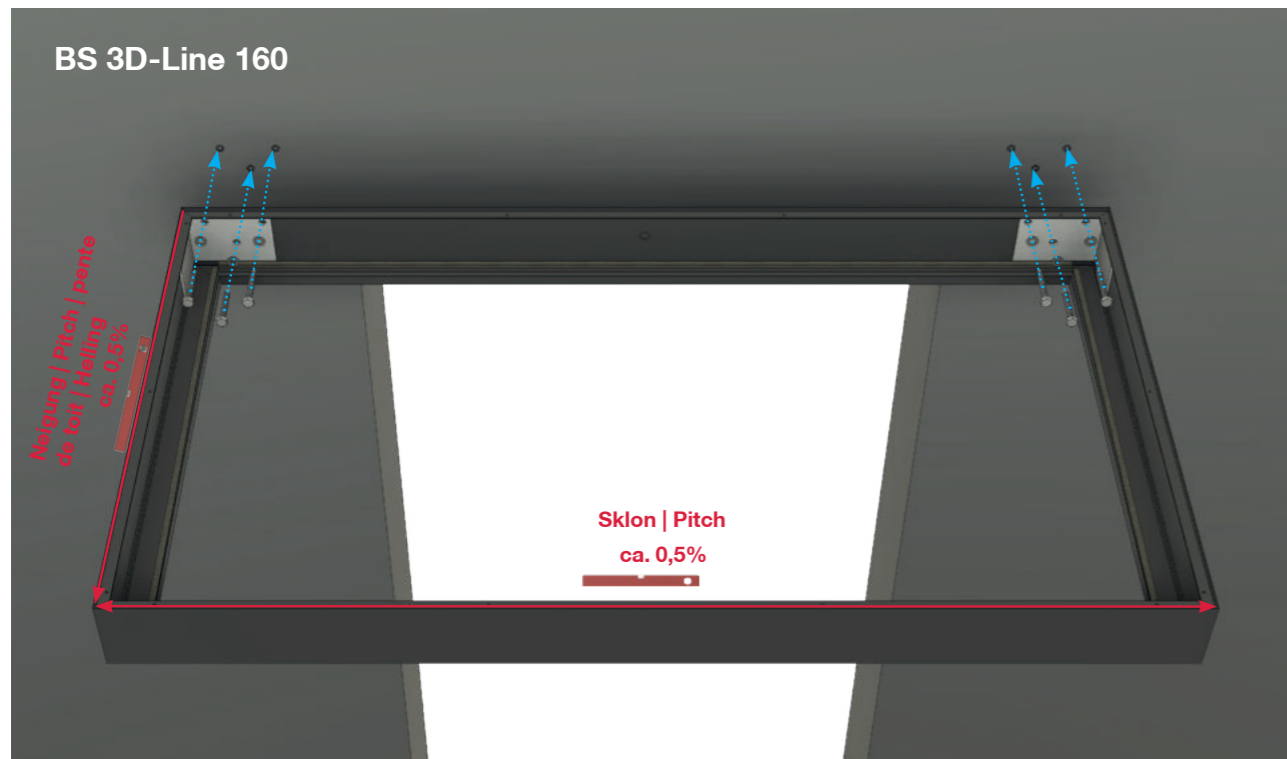
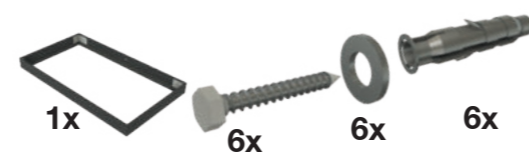

Sklon -> Směrem odtoku
 Pitch -> Downpipe direction |

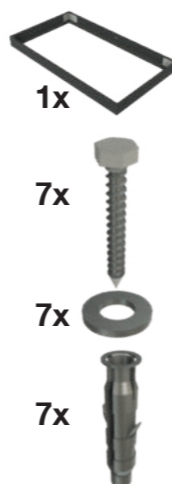
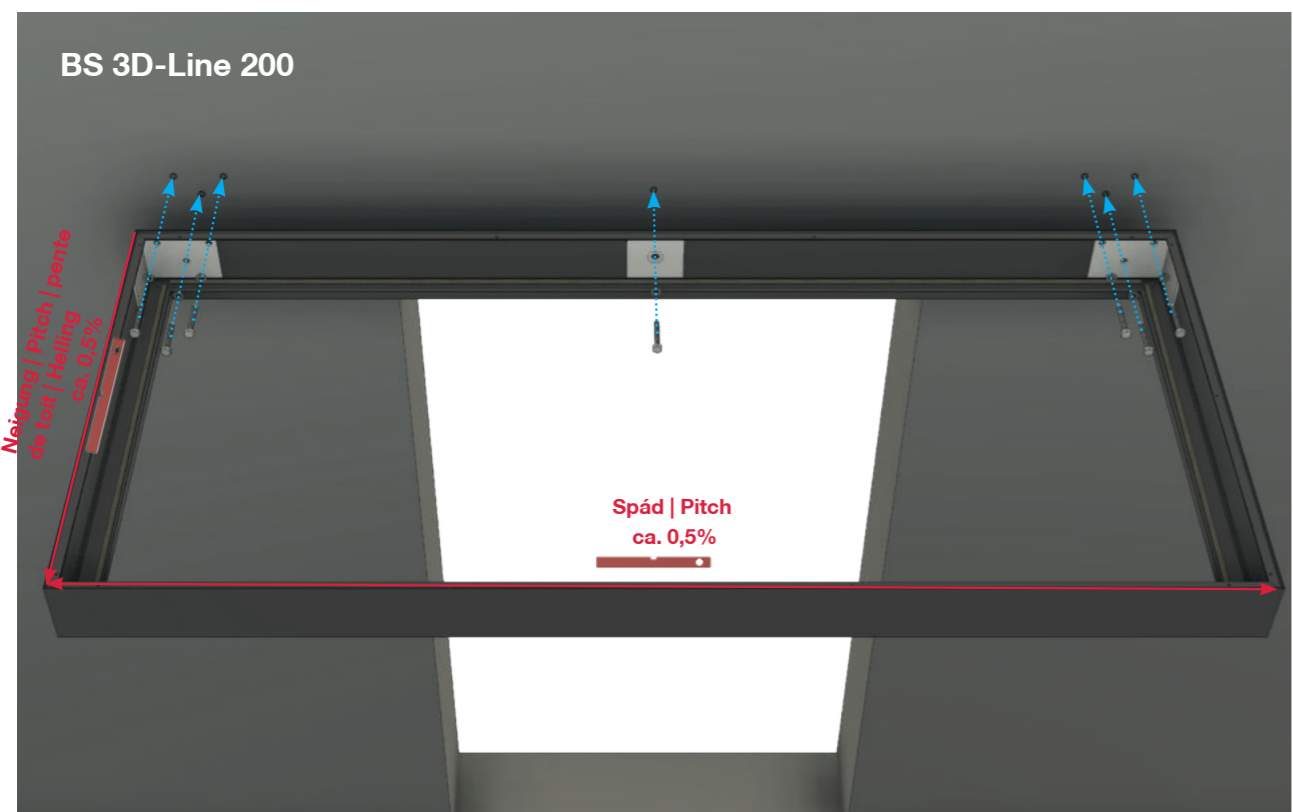

Montáž chrliče
Assembly waterspout

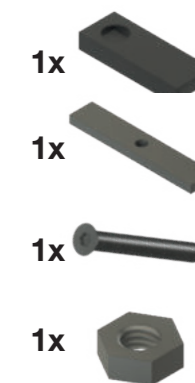
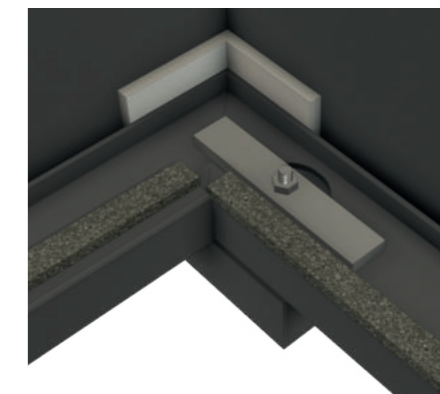
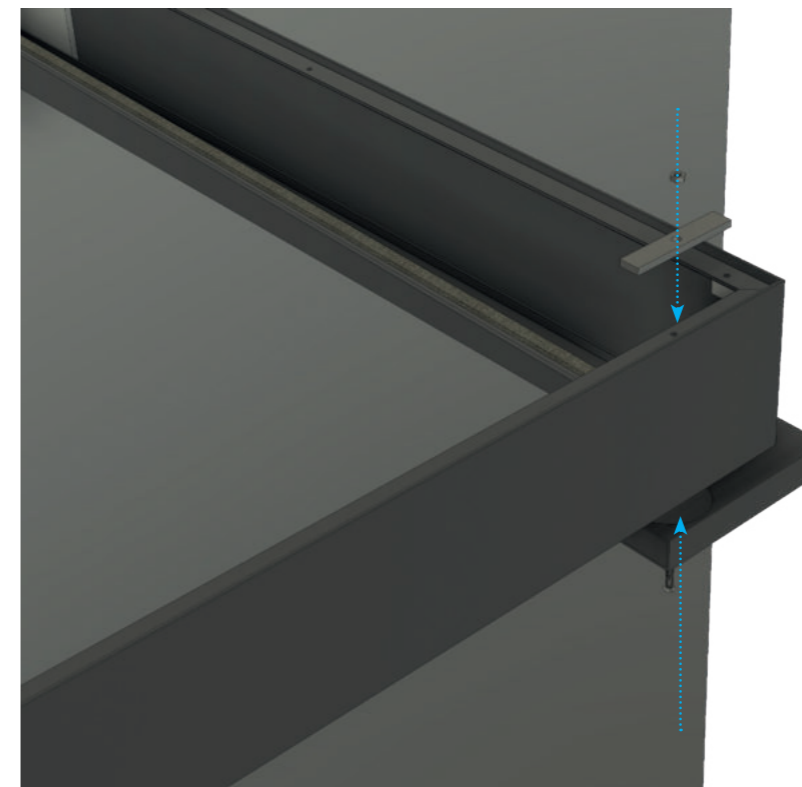

Montáž chrliče vlevo nebo vpravo
 Mounting waterspout optionally on the left or right side

Montáž polykarbonátové desky do vnitřního rámu

| Mounting plate and inner angle

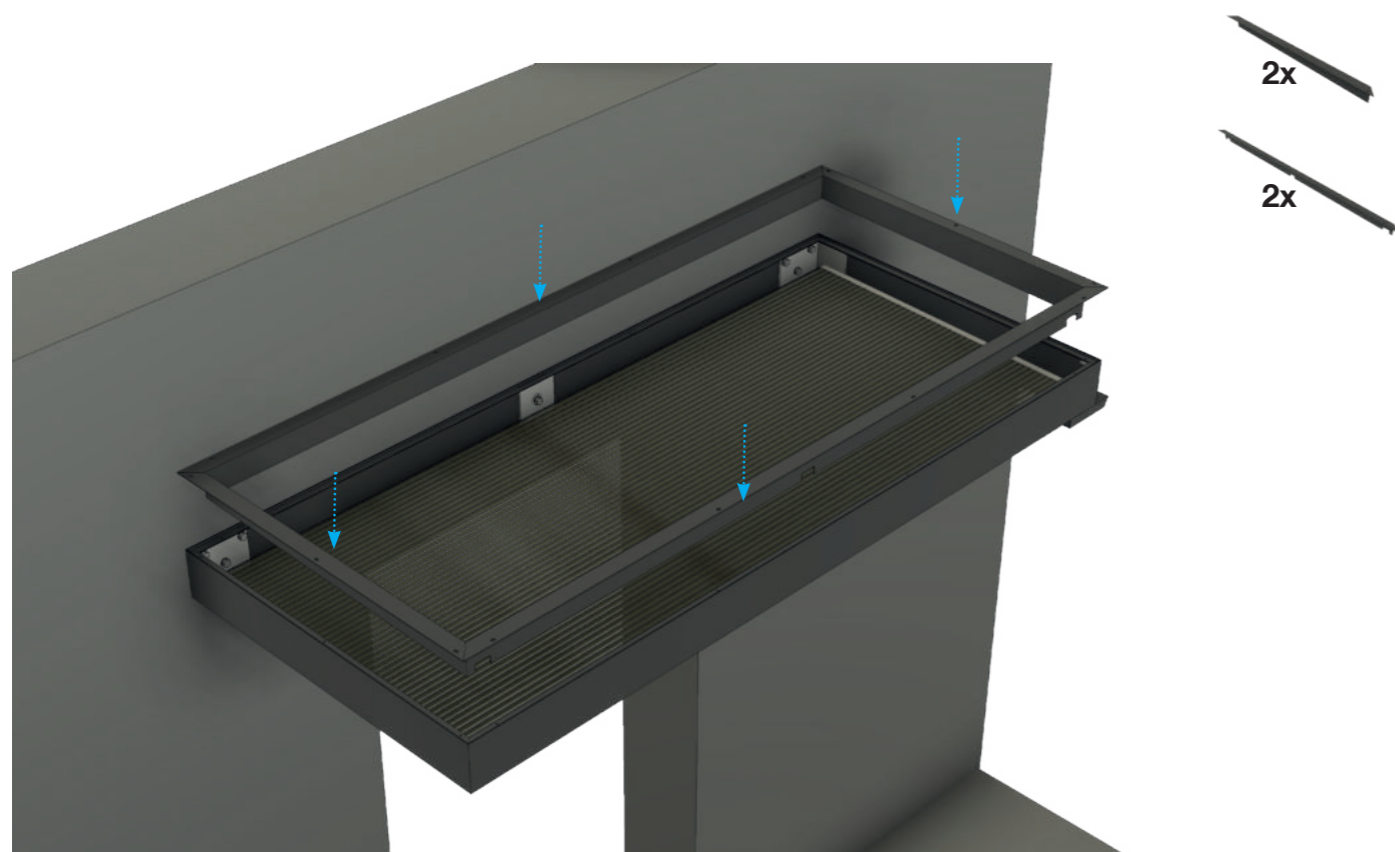
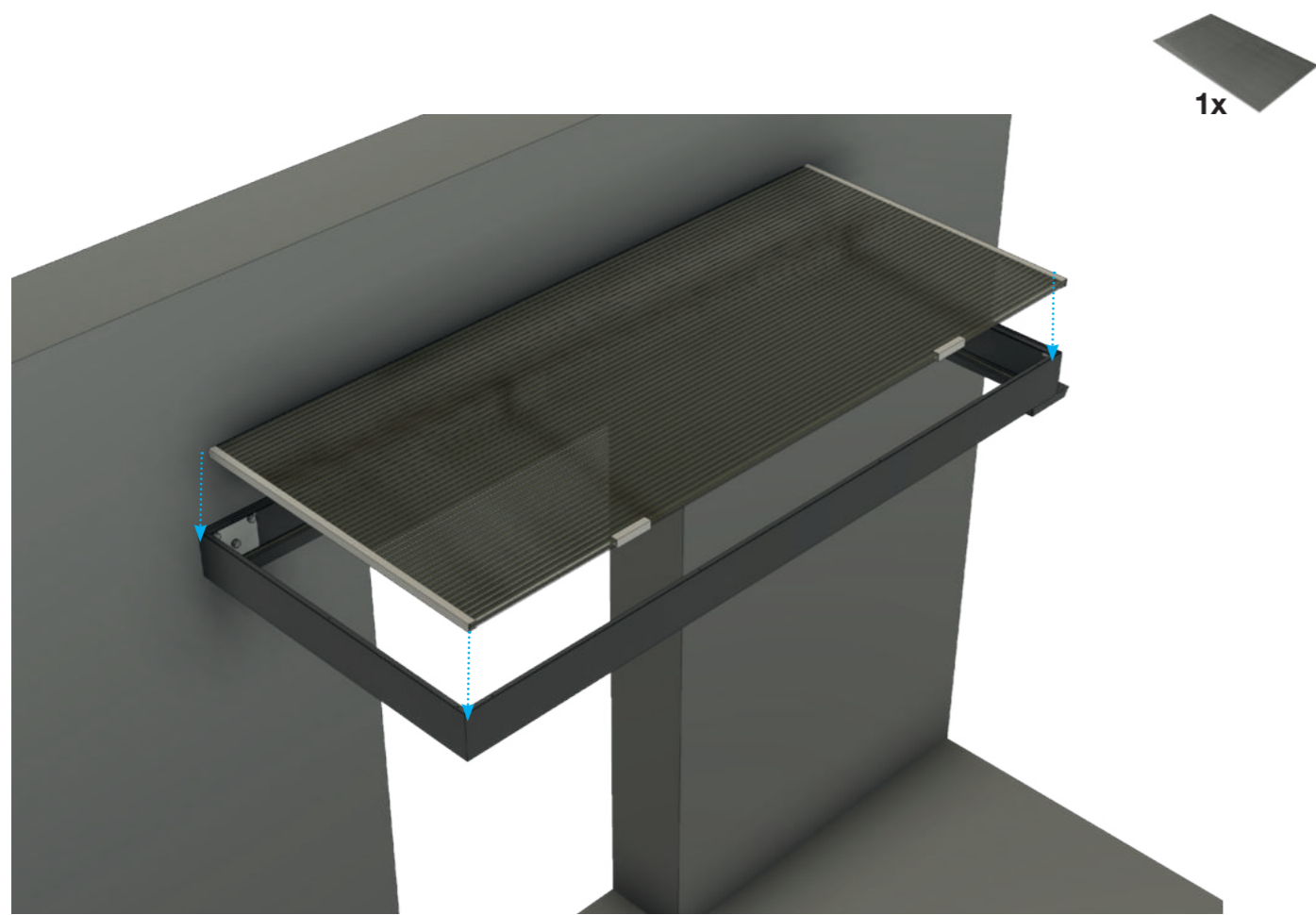

Uchytení vnitřního rámu a montáž záslepek

| Fastening inner angle and mounting blind plug

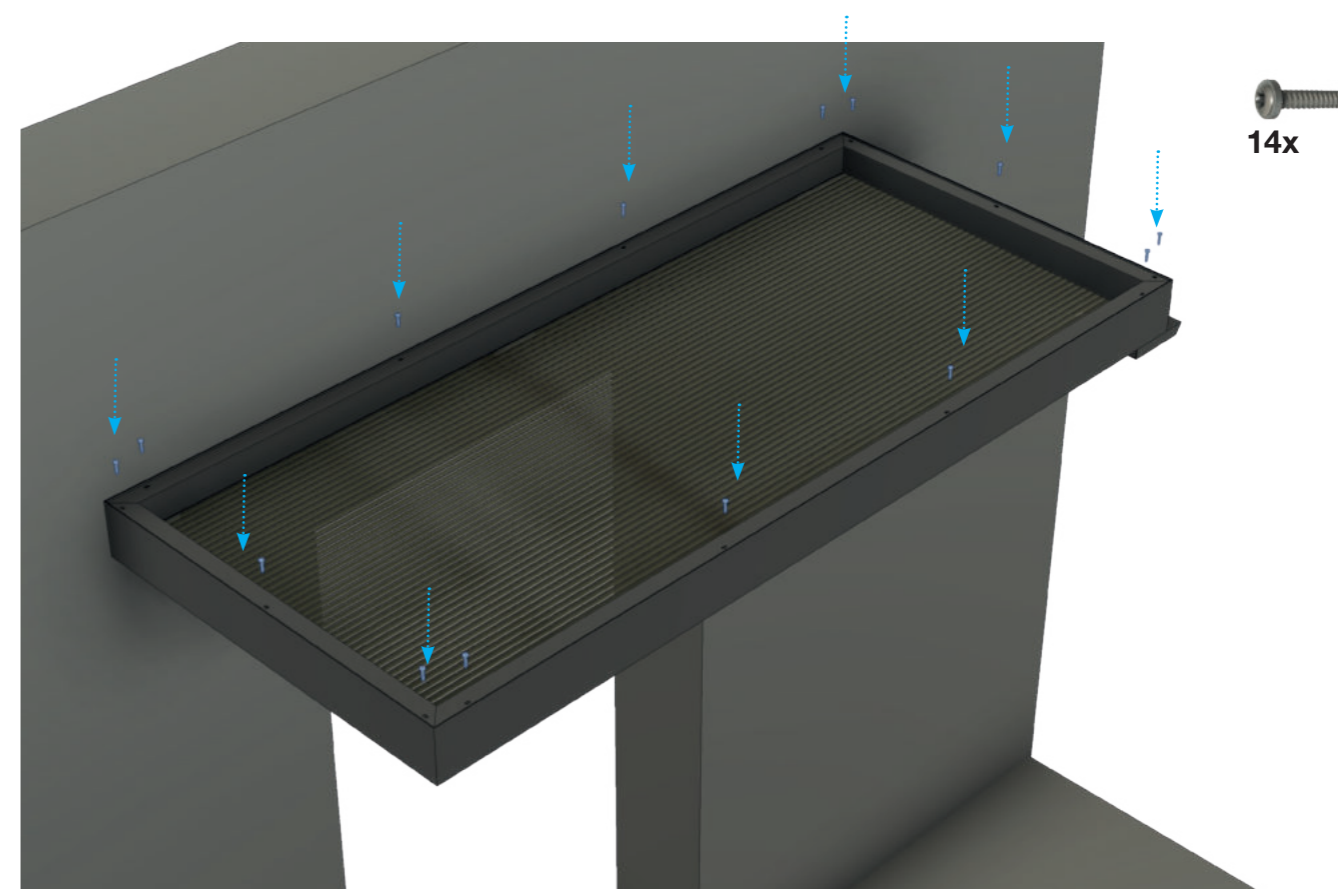

Montáž záslepek vlevo nebo vpravo

| Mounting blind plug optionally on the left or right side

Těsnění stříšky na stěnu domu
| Waterproofing canopy - house wall

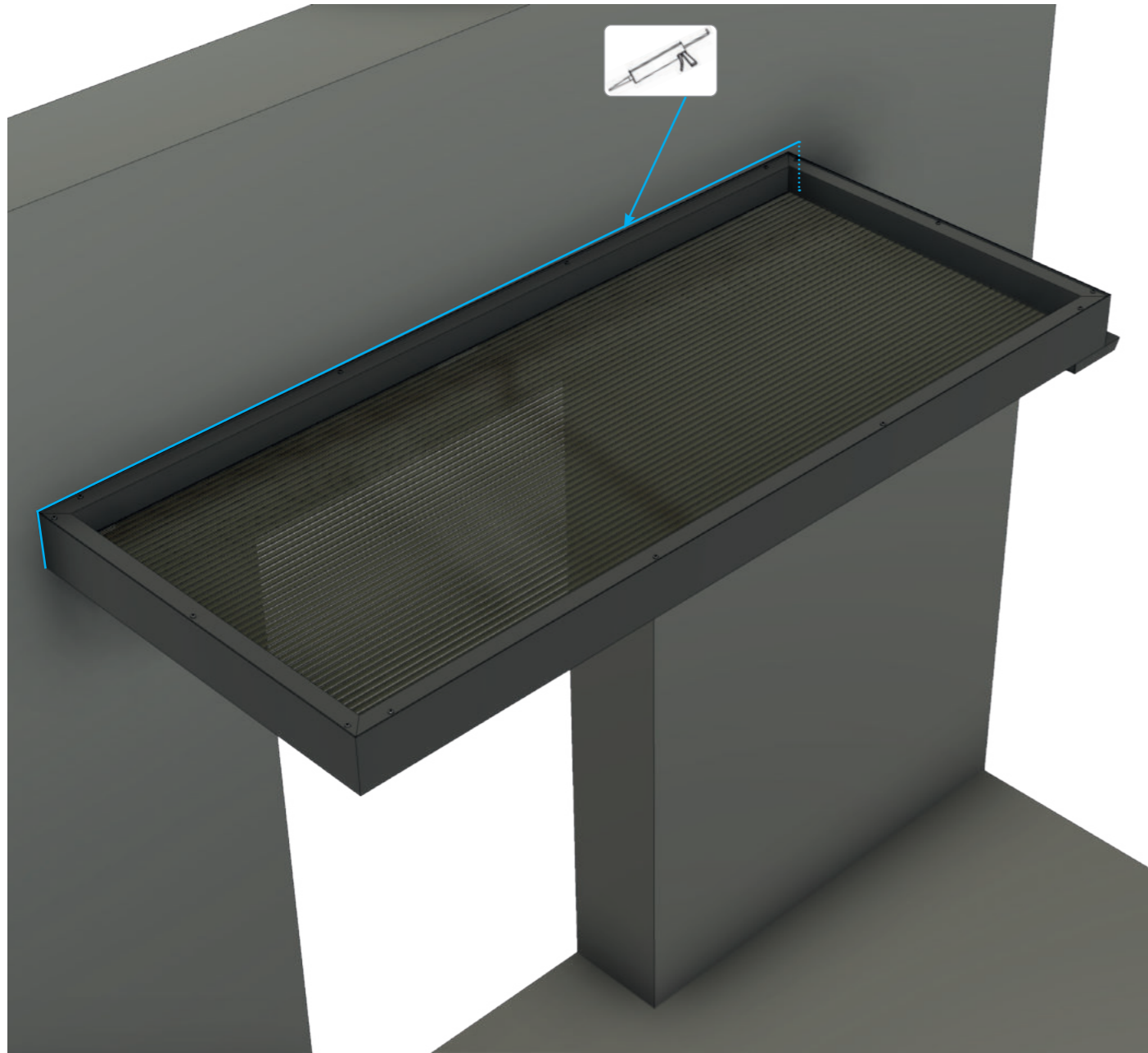

Produkty / Overview of product range



Dutinkové desky
Twinwall sheets



Vlnité desky
Profile plates



Vchodové stříšky
Canopies



Hliníkové pergoly
Terrace roofs

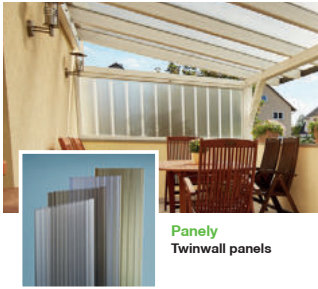

Panely
Twinwall panels



Plexisklo
Polystyrene sheets



Shelltec
Corrugated sheets



Gutta Shelltec
Corrugated recycling sheets

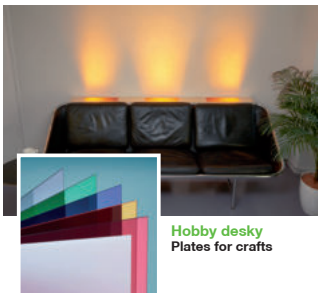

Hobby desky
Plates for crafts



Zatrávňovací tvárnice
Lawn grids



Zahradní produkty
Garden products



Nopové fólie
Dimpled Membrane

... a mnohem více !
... and much more !



Prémiové výrobky pro stavbu, dům a zahradu

